

Installation Note

Agilent PSA Series Spectrum Analyzers Switchable Microwave Preselector Bypass Option 123



Agilent Technologies

Part Number E4440-90329 Supersedes: E4440-90309
Printed in USA July 2006



E4440-90329

Notice.

The information contained in this document is subject to change without notice.

Agilent Technologies makes no warranty of any kind with regard to this material, including but not limited to, the implied warranties of merchantability and fitness for a particular purpose. Agilent Technologies shall not be liable for errors contained herein or for incidental or consequential damages in connection with the furnishing, performance, or use of this material.

Switchable Microwave Preselector Bypass Installation Kit

Products Affected:	PSA E4440A PSA E4443A PSA E4445A
Serial Numbers:	US4430 / US9999 MY4430 / MY9999
To Be Performed By:	<input checked="" type="checkbox"/> Agilent Service Center <input checked="" type="checkbox"/> Personnel Qualified by Agilent <input type="checkbox"/> Customer
Estimated Installation Time:	4 Hours
Estimated Adjustment and Verification Time:	3.5 Hours (see note 2)
Additional Recommended Task	Agilent recommends that a full calibration be performed to verify instrument specifications. (see note 3)

Introduction

This installation note explains how to install the Switchable Microwave Preselector Bypass into newer instruments that have the serial prefix listed above. These instruments already contain the proper Front End Driver assembly required to support this retrofit kit. There is another kit, Option 423, that is designed for earlier instruments that require the latest Front End Driver assembly.

Because the mixer in this kit requires the same SLODA LO output that the external mixing option AYZ requires, the two options cannot be installed at the same time.

The retrofit adds a switchable alternate signal path when the analyzer start frequency is above 3.05GHz. This alternate path bypasses the preselector filter and mixer in the normal highband path. The advantage of bypassing the preselector is that the preselector filter will drift with time and temperature and will cause small amplitude errors.

When the preselector is bypassed, images, multiples and out of band responses will appear on the analyzer display since there is no longer a bandpass filter present to limit the input frequency range of the analyzer. Therefore, the display may show many signal responses even though only one response is the true signal. Since the preselector can be switched in or out easily, it is possible to find a signal in preselected mode and tune to it, then switch the preselector out and measure it.

NOTE 1. This option is licensed for one instrument model number/serial number combination. The license key will only install on the designated instrument.

NOTE 2. The installation of this kit requires that some re-adjustment and performance testing be performed in order to assure the new option is functioning properly. This installation note includes a list of required adjustments and performance tests. Completing the list of required performance tests does not guarantee the instrument meets all specifications.

NOTE 3. The instrument end user must determine whether they need a full instrument calibration following the installation of the kit. If full calibration is required, arrangements regarding the level of calibration must be made between the end user and the calibration provider.

Contents

Quantity	Description	Agilent Part Number
1	Installation Note	This note
1	Option Upgrade Entitlement Certificate	5964-5141
1	User's Guide, Volume 1	---
1	Specifications Guide	---
1	Dual mixer	5086-7749
1	Switch/Bracket Assembly	N/A
1	W80, Cable, semi-rigid, Input Attenuator to SW1 port C	E4440-20090
1	W81, Cable, semi-rigid, SW1 port 2 to RYTHM	E4440-20091
1	W82, Cable, semi-rigid, SW1 port 1 to Mixer input	E4440-20092
1	W83, Cable, semi-rigid, Mixer LO IN to W88	E4440-20093
1	W84, Cable, semi-rigid, Mixer Out to SW2 port 1	E4440-60383
1	W86, Cable (10), coax, 3rd converter to SW2 port C	E4440-60382
1	W87, Cable (2), coax, RYTHM to SW2 port 2	E4440-60381
1	W88, Cable, semi-rigid, SLODA LO Out to cable W83	E4440-20087
1	W111, Cable, semi-rigid, SW 6 port 2 to SW 1 port C (Option 123/110 combo)	E4440-20317
1	W115, Cable semi-rigid, FL4 to A34 mixer (Option 123/110 combo)	E4440-20324
1	FL4, High Pass filter, 3 GHz (Option 123/110 combo)	0955-1906
1	50 Ohm Load (SMA)	1810-0118
2	Cable tie .062D .09W	1400-0249
5	Screw, M3 X 0.5 8 MM-LG	0515-0372

Tools Required

- T-20 Torx driver
- T-10 Torx driver
- 5/16-inch open end wrench/torque wrench
- 1/4-inch open end wrench
- Calibration software. Latest software information and downloads available at <http://www.agilent.com/find/calibrationsoftware>
- Test equipment supported by the calibration software.
- PSA Series Spectrum Analyzer and Service Guide. This manual is available as part of the E4440AU, E4443AU, or E4445AU Option OBW kits.
- Microsoft Windows based personnel computer
- Windows 2000, Windows XP
- Firmware A.0 6.00 or later. Download the latest revision form http://www.agilent.com/find/psa_firmware, or order the Firmware Update kit.

Depending on your model number, the firmware update kit is ordered as: Order E444xAU (Qty.1) Option UE2 (Qty. 1), where the “x” is the last digit of the model number. For example: E4440AU option UE2.

Installation Procedure

For assistance at any time during this procedure, get in touch with your nearest Agilent Technologies Sales and Service Office. To find your local Agilent office access the following URL:

<http://www.agilent.com/find/assist>

Preliminary Hardware Verification

1. Install version A.06.00 or Greater if Needed

- Press **System, More, Show System**. The firmware revision needs to be A.06.00 or later.
- If the firmware needs to be updated, do the following.

Download the PSA Update Program and the PSA Firmware Procedure from http://www.agilnet.com/find/psa_firmware

Follow the instructions to install the firmware

Alternate Method:

Install the Firmware Update Kit E4440AU Option UE2. Follow the directions in the kit.

2. Check for the presence of Option AYZ, External Mixing, by pressing **System, More, Show System**, and look at the option list.

- If Option AYZ is present it must be uninstalled before Option 123 can be installed.
 - a. Delete Option AYZ License by pressing **System, More, More, Licensing, Option**. Use the front panel numerical key pad to enter the option designator AYZ and press the **Enter** key. Press **Delete Option**.
 - b. Check that Option AYZ has been removed by pressing **System, More, Show System**, and looking at the option list.
 - c. Follow the instructions in this installation note in the section named [“Uninstalling Option AYZ”](#) to remove the Option AYZ hardware.
- If Option AYZ is not present, then skip the section named [“Uninstalling Option AYZ”](#).

3. Check for the presence of Option 110, Preamplifier by pressing **System, More, Show System**, and look at the option list.
 - If Option 110 is present follow the instructions in this installation note in the section named [“Installing Option 123 with Option 110”](#).
 - If Option 110 is not present then follow the instructions in this installation note in the section named [“Installing Option 123 without Option 110”](#).

Before you begin the kit installation:

The instrument should be fully functional and pass all of the power on align tests. If an alignment test fails, either note the failure and go on with the kit installation or repair the problem now. Since the following installation involves removing and replacing cables and removing and reinstalling major assemblies, you must be aware of the instrument status before you begin the kit installation.

Remove the Outer Case

CAUTION If the instrument is placed on its face during any of the following procedures, be sure to use a soft surface or soft cloth to avoid damage to the front panel, keys, or input connector.

1. Disconnect the instrument from ac power.
2. Refer to [Figure 1](#). Remove the two handles on the sides of the instrument as shown. Use the T-20 driver to loosen the screws that attach each handle (1). Remove the handles.
3. Remove the four bottom feet (2). Lift up on the tabs on the feet, and slide the feet in the direction indicated by the arrows.
4. Remove the four screws (3) that hold the rear feet (4) in place.
5. Pull the instrument cover (5) off toward the rear of the instrument.

Figure 1 Instrument Outer Case Removal

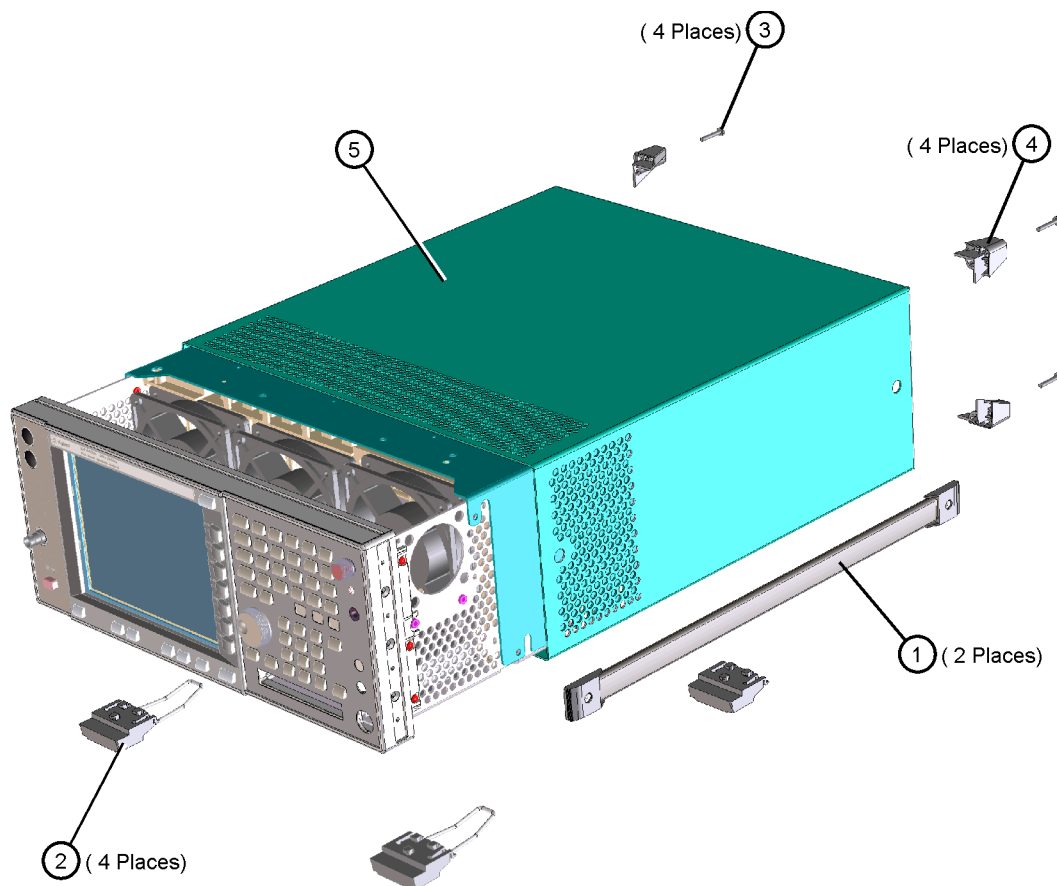

de83a

Remove the Top Brace

1. Refer to [Figure 2](#). Use the T-10 driver to remove the top screws (3) (one screw is under the security label), and the side screws (2) attaching the top brace (1) to the deck.
2. Remove the top brace from the deck.

Figure 2 **Top Brace Removal**

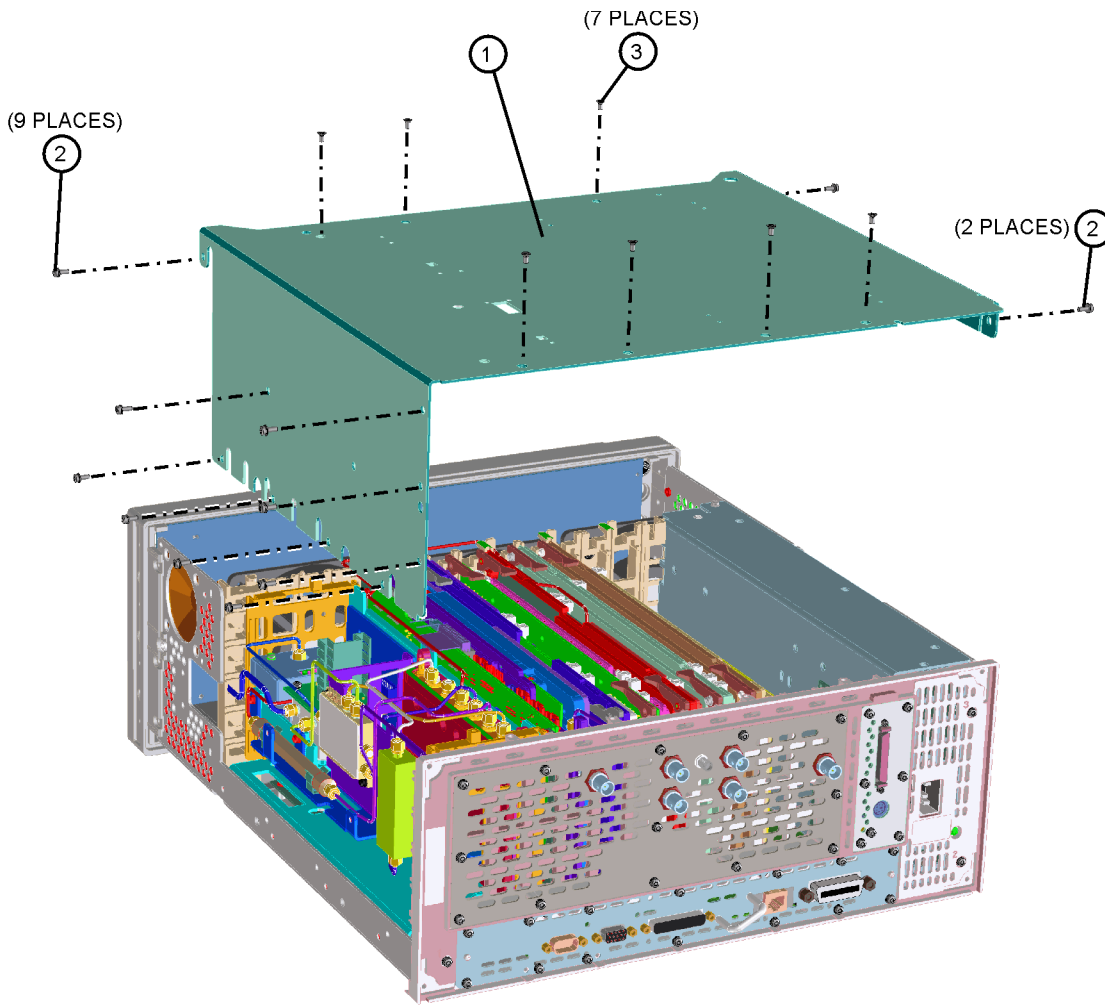

Uninstalling Option AYZ

1. Refer to [Figure 3](#). Locate and disconnect semi-rigid cable W45 from W46. Remove W46 from A21 SLODA.

Figure 3 W45 and W46 Cable Location

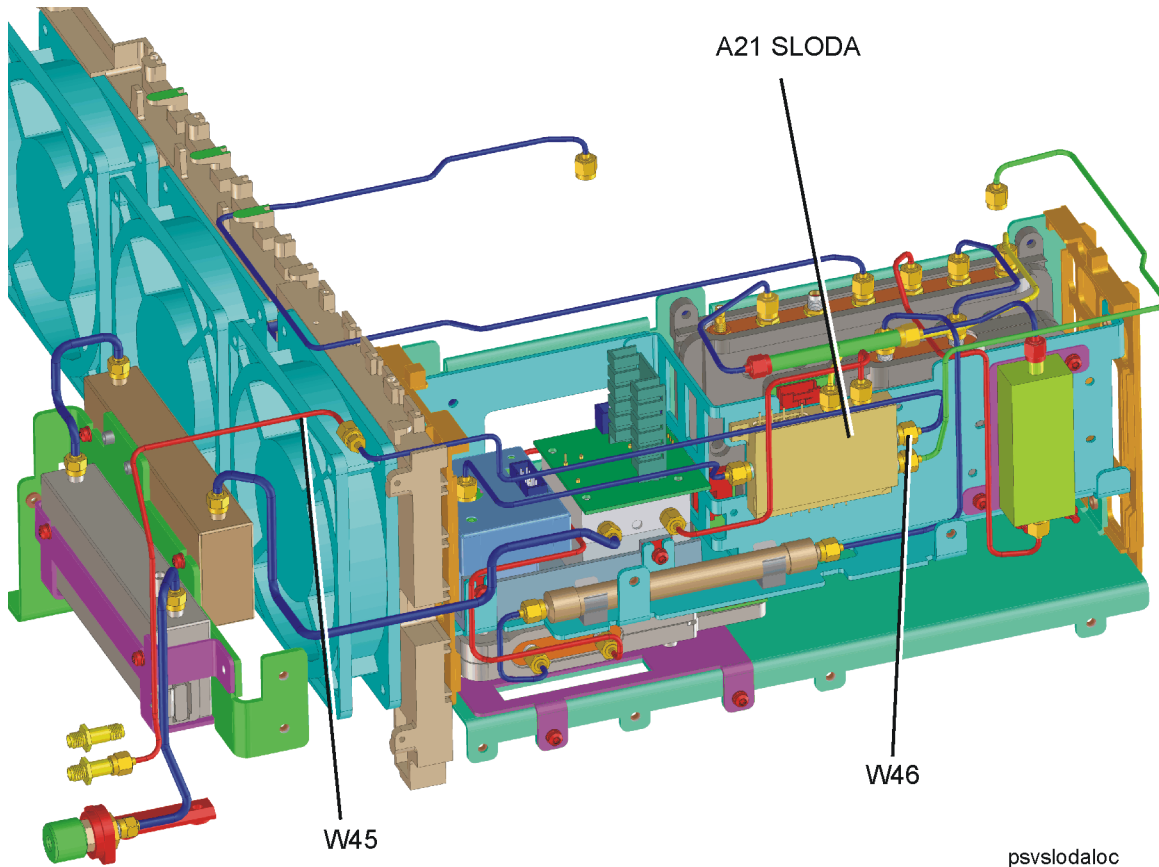

2. Remove the front frame as described in the instructions in this installation note under the section called **“Remove the Front Frame”**. If Option 110 is present then cable W109 and W110 must be removed before the front frame can be removed. See [Figure 5](#).
3. Refer to [Figure 4](#). Remove cable W45 from the front panel 1st LO Out. Discard this cable.

Figure 4 W45 Cable Location at Front Panel

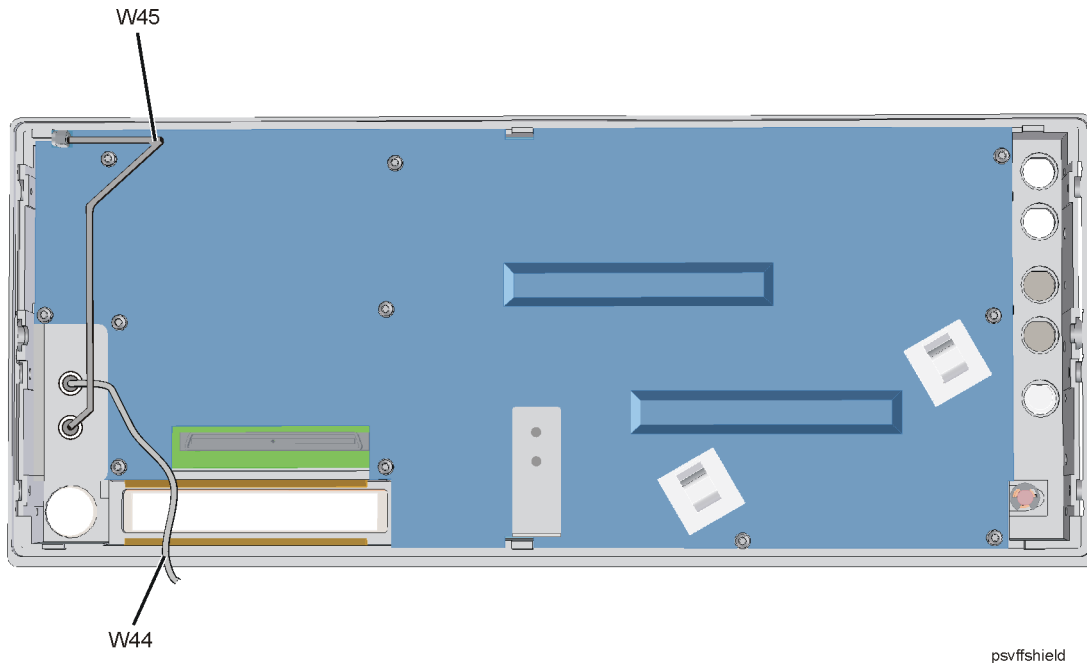

4. Locate and remove cable W44 (IF Input on the front panel to J3 on the 3rd Converter Assembly). Discard this cable.
5. Remove the 50 ohm load from the front panel LO out connector. Save this 50 ohm load for a later step.
6. Locate the two SMA Hole Plugs (6960-0076) from the kit.
7. Remove the 1st LO Out and IF Input Front Panel SMA Connectors with a ¼ inch deep socket. Ensure you do not scratch the front panel. Discard the SMA connectors and replace them with the SMA Hole Plugs.

Installing Option 123 with Option 110

1. Locate cable W110 and disconnect it from Switch SW6 Port 3. This is disconnected to allow the Front Frame to be removed.

Figure 5 W110 Cable Location

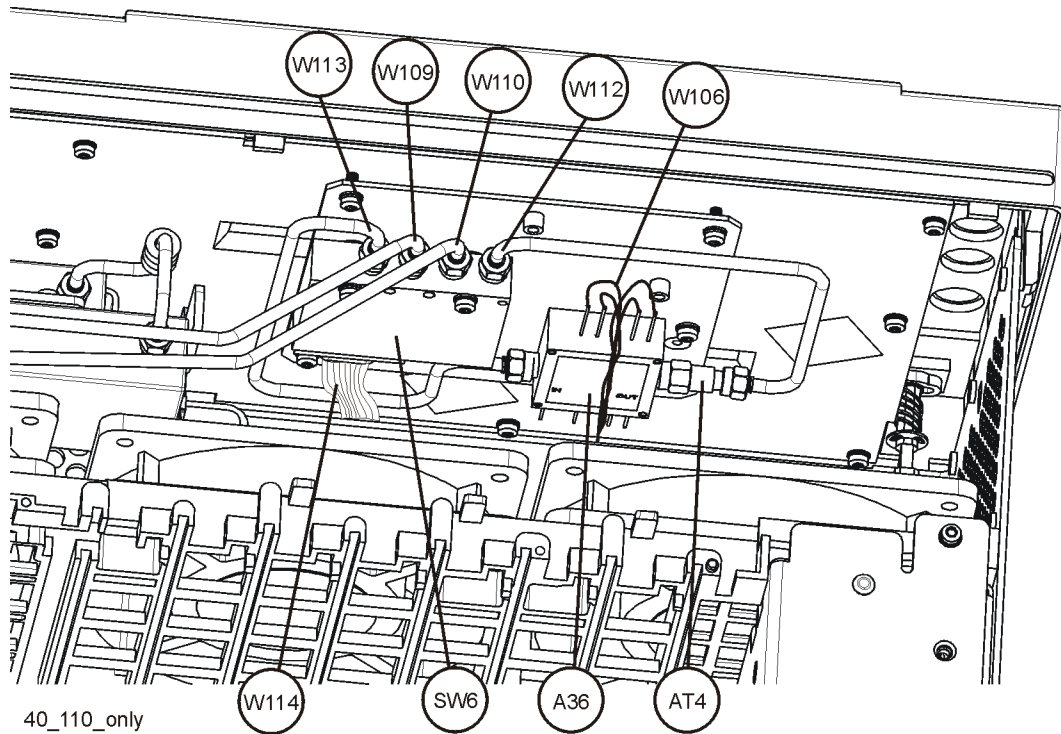

2. Locate cable W109 and disconnect it from Switch SW6 Port 2. This is disconnected to allow the Front Frame to be removed.
3. Remove the Front Frame as described in the instructions in this installation note under the section called [“Remove the Front Frame”](#).
4. Refer to [Figure 6](#). Locate the input attenuators near the RF input and remove the W8, E4440-20068 rigid cable that connects the two attenuators. This cable will be reused later.

Figure 6 Cable Locations

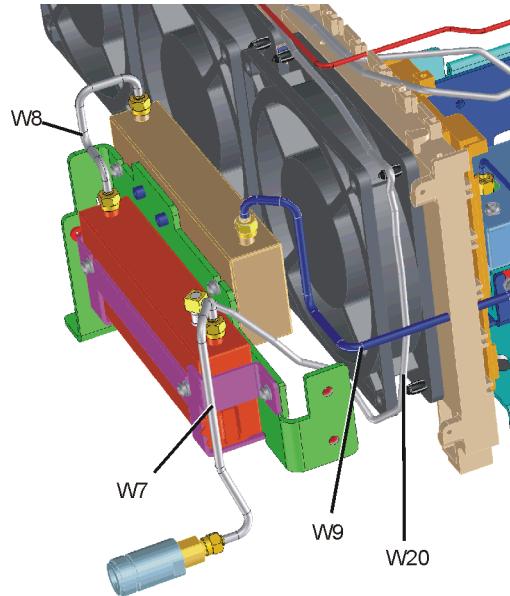

attencables

5. Disconnect the other end of cable W110 from the RYTHM. Discard this cable as it will be replaced by another cable.
6. Disconnect the other end of cable W109 from the A15 Attenuator. This cable will be replaced later. It is removed to allow the Switch/Bracket Assembly to be installed.
7. Locate the switch/bracket assembly in the retrofit kit ([Figure 7](#)) and place it over the attenuators as shown in [Figure 8](#). Secure the switch/bracket assembly to the attenuator bracket with the 0515-0372 screws provided in the kit. Torque to 9 in-lbs.

Figure 7 Switch/Bracket Assembly

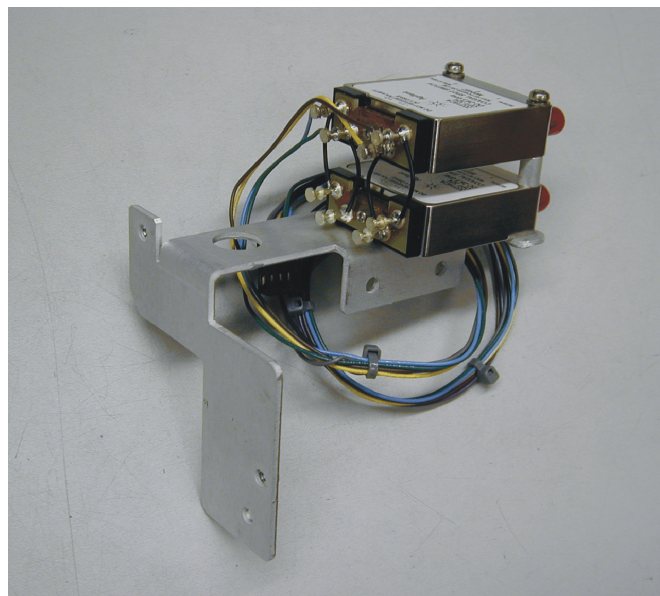

8. Locate the Dual Mixer in the kit. Look at the wire harness attached to the switch/bracket assembly and locate the grey and violet wires.
9. Refer to [Figure 9](#) to determine how the Dual Mixer will attach, but do not attach the mixer yet. Connect the grey wire with the push on connector to the Dual Mixer bias pin. Connect the violet wire with the push on connector to the Pin 7 SW on the Dual Mixer.

Figure 8 Mixer and Cable Locations

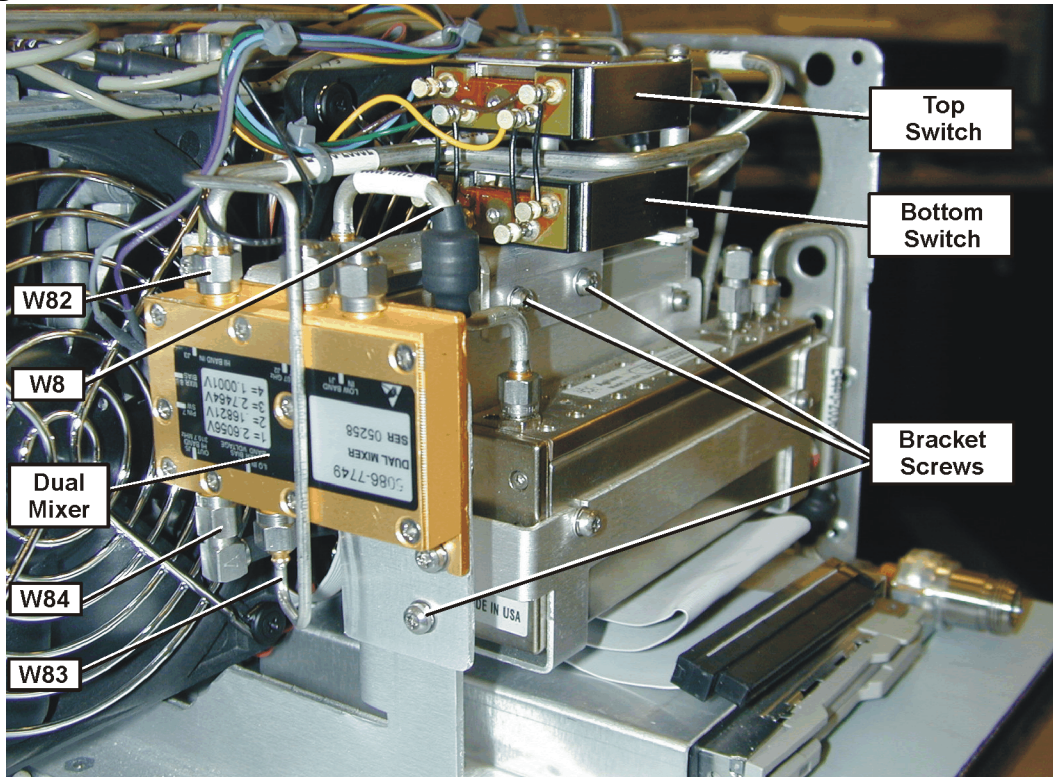

10. Refer to [Figure 9](#). Attach the Dual Mixer to the end of the switch bracket using two of the screws in the kit. Before inserting the top screw, locate the black wire with the ground lug that is part of the switch harness. Place the ground lug between the screw head and the mixer body. Torque the mounting screws to 9 in-lbs.

Figure 9 Mixer Installation

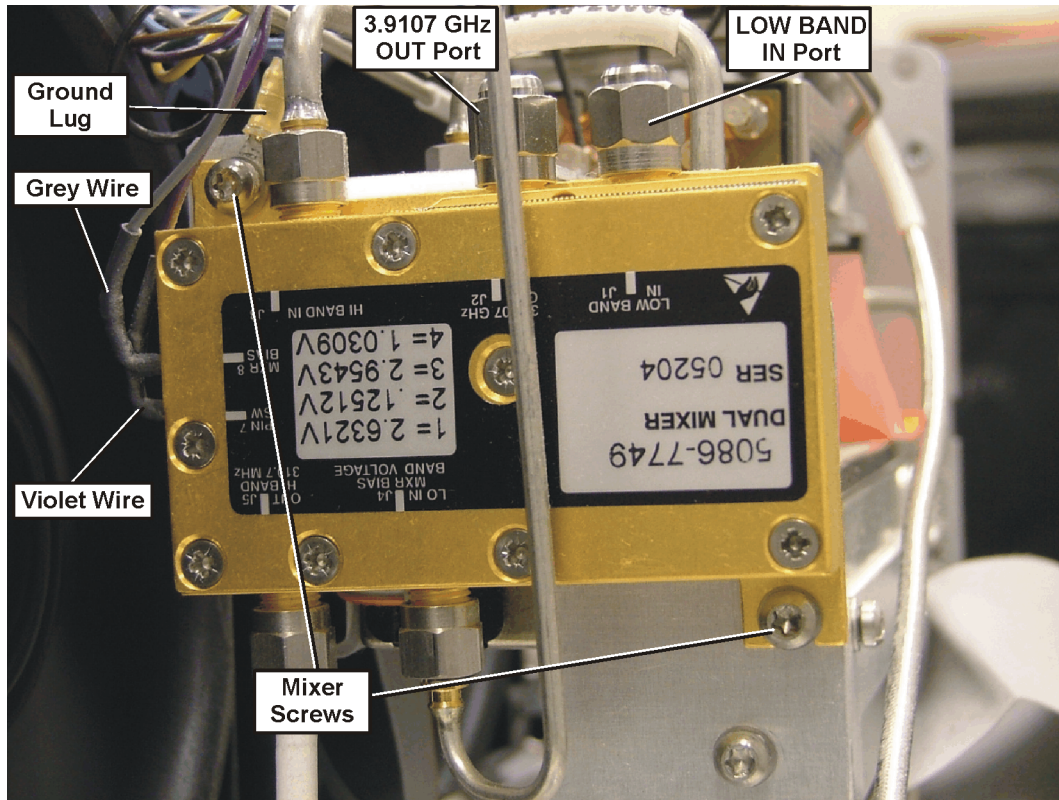

11. Refer to [Figure 6](#). Remove the W9, E4440-20069 rigid cable from the RYTHM to the attenuator. This cable can be discarded.

12. Refer to [Figure 10](#). Reattach the W8 rigid cable between the two attenuators. Torque to 10 in-lbs.

Figure 10 W8 Cable Location

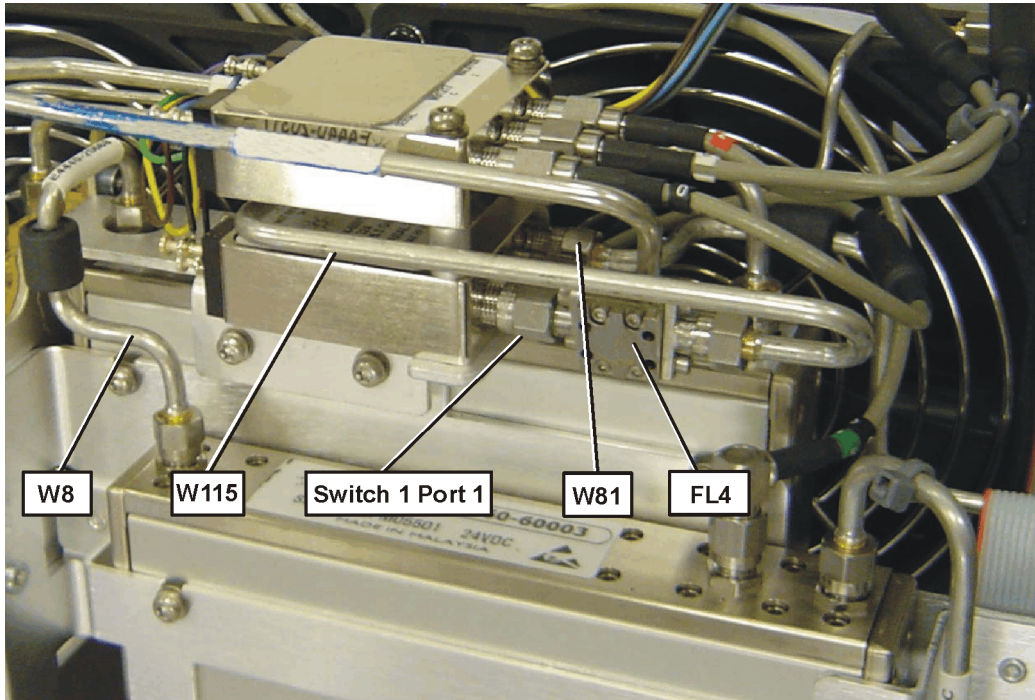
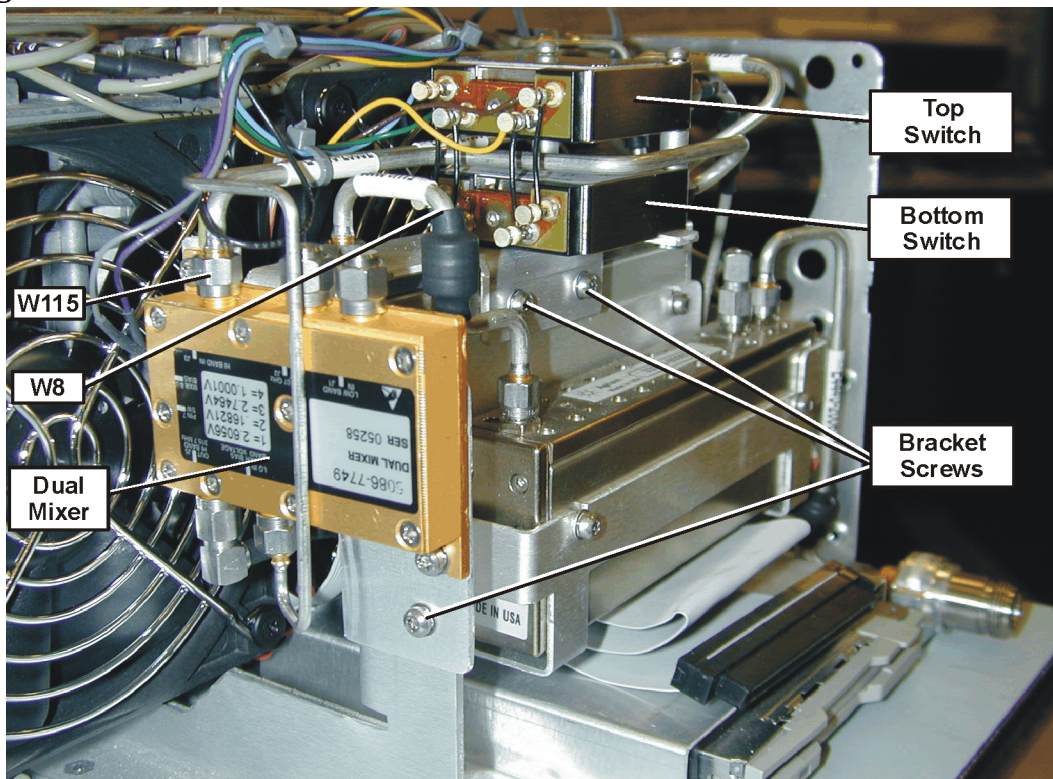

Figure 11 Mixer and Cable Locations



Installation Procedure

13. Locate High Pass Filter FL4 from the kit. Refer to [Figure 10](#). Connect Filter FL4 to the bottom switch port 1. Torque to 10 in-lbs.
14. Locate the W115 semi-rigid cable from the kit. Refer to [Figure 10](#) and [Figure 11](#). This cable will connect between the filter on bottom switch Port 1, and the Dual Mixer port “HI BAND IN J3”. The cable must be routed between the switches. To do this, make sure the flat portion of the connector nut is positioned so the end of the cable will fit between the switches. Torque the cable to 10 in-lbs.
15. Locate the W81 rigid cable in the kit. Refer to [Figure 10](#) and [Figure 12](#). This cable will connect between bottom switch Port 2, and the RYTHM port.

Figure 12 W81 Location

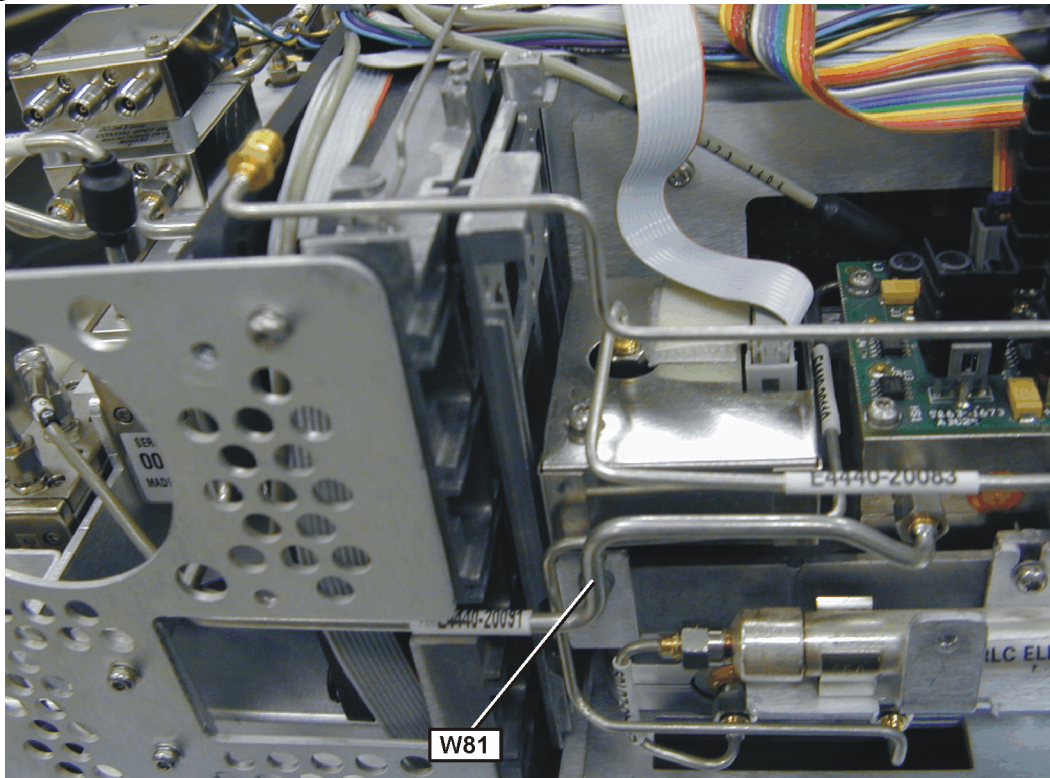

16. Refer to [Figure 13](#). On the instrument, locate the flexible coax “10” cable that connects between the A10 Third Converter J1 and RYTHM. Remove the cable from Third Converter J1.

Figure 13 Top View

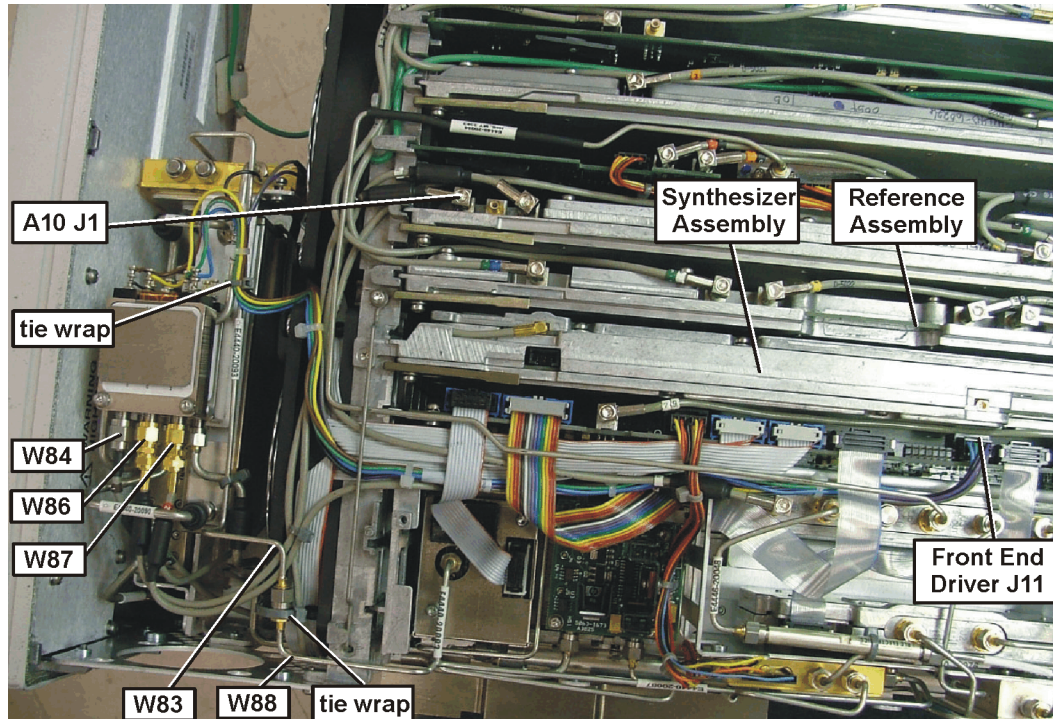

17. Remove the screw from the cable hold down rod on the mid web to allow the “10” cable and other cables to be free.
18. In order to remove the RYTHM end of the cable, and replace the cable, several board assemblies must be removed. Please note the position and routing of all cables. All of the flexible coax cables are color coded, but the ribbon cables are not.
19. Remove the Front End Driver being careful to avoid damaging the ribbon cables.
20. Remove the Synthesizer assembly after removing the rigid cable and the two retaining screws.
21. Remove the Reference assembly.

22. Locate the “10” cable again, and take note of the cable routing. Refer to [Figure 14](#). Using needle nose pliers, carefully grab the body of the “10” cable smb connector and gently rock the smb connector free of the RYTHM. Discard the cable.

Figure 14 RYTHM SMB Connector

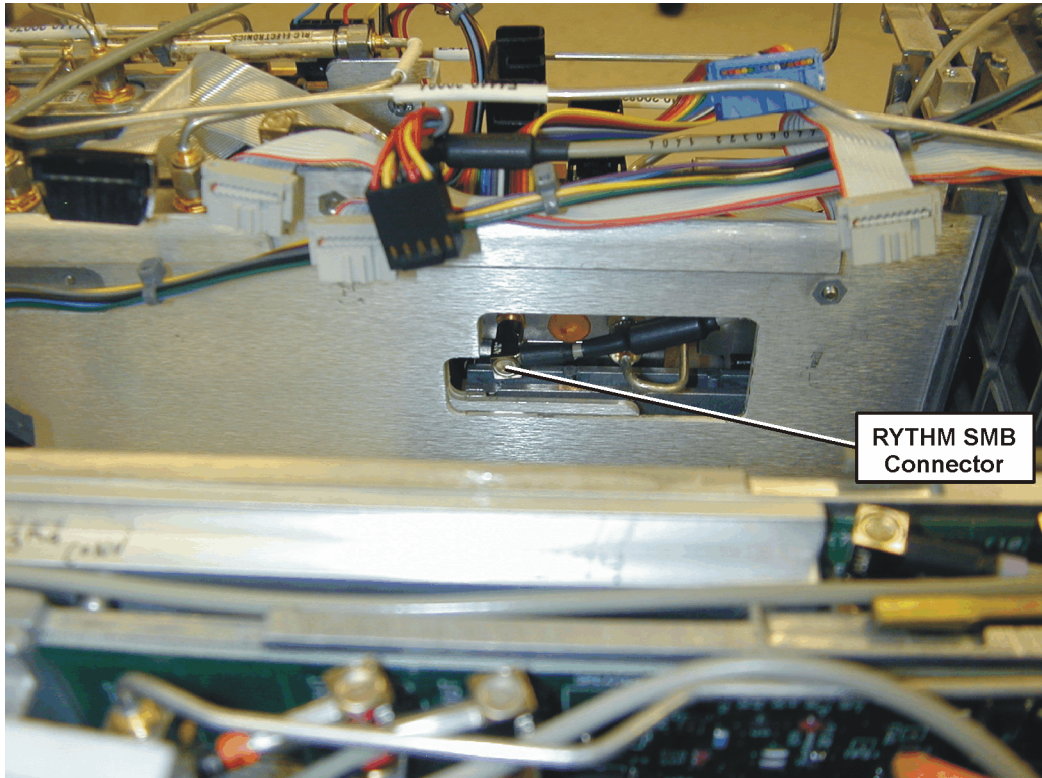

23. Locate the W87 flexible coax in the kit. This cable has a “2” color code and connects from port 2 of the top switch to the smb connector on RYTHM. Torque to 10 in lbs. Route the cable next to the RF section sheet metal and directly to the RYTHM. Carefully align the SMB end of the cable with the RYTHM connector by looking through the hole in the chassis. Press the SMB connector on.
24. Reinstall the A13 Front End Driver, Synthesizer Assembly and the Reference Assembly. Assure all cables are routed correctly.
25. Locate the W86 flexible coax cable in the kit. This cable has a “10” color code on one end and a “C” on the other end. Refer to [Figure 13](#). Connect the SMA end of the cable to the center port of the top switch. Torque to 10 in lbs. Attach the other end of the cable to the A10 Third Converter J1 connector.

NOTE The shrink-wrapped ferrite beads on the cable can be moved slightly to aid cable routing.

26. Locate the W84 flexible cable in the kit. This cable has a right-angle SMA connector on one end. Refer to [Figure 10](#) and [Figure 11](#). Connect the end of the cable with the straight SMA connector to port 1 of the top switch. Route the cable under the attenuator and to the Dual Mixer “OUT” J5 port. Connect the cable being careful that the right-angle connector is clear of the cooling fan. Torque the connectors to 10 in-lbs.
27. Refer to [Figure 15](#). Locate the SLODA (LO distribution amplifier) in the RF section. Remove the 50 ohm load from the 1st LO OUT port. If Option AYZ was previously uninstalled the load will not be present.
28. Refer to [Figure 9](#). Place the 50 ohm load on the Dual Mixer 3.9107GHz OUT port. If Option AYZ was previously uninstalled use the 50 ohm load that was saved from the section titled “[Uninstalling Option AYZ](#)”, [step 5](#).
29. Locate the 50 ohm load in the kit and install it on the Dual Mixer, LOW BAND IN port.
30. Locate the W88 rigid cable in the kit. Refer to [Figure 15](#). Attach one end to the LO OUT port of the SLODA. The other must lay against the fan near the upper fan mounting hole.

Figure 15 RF Section

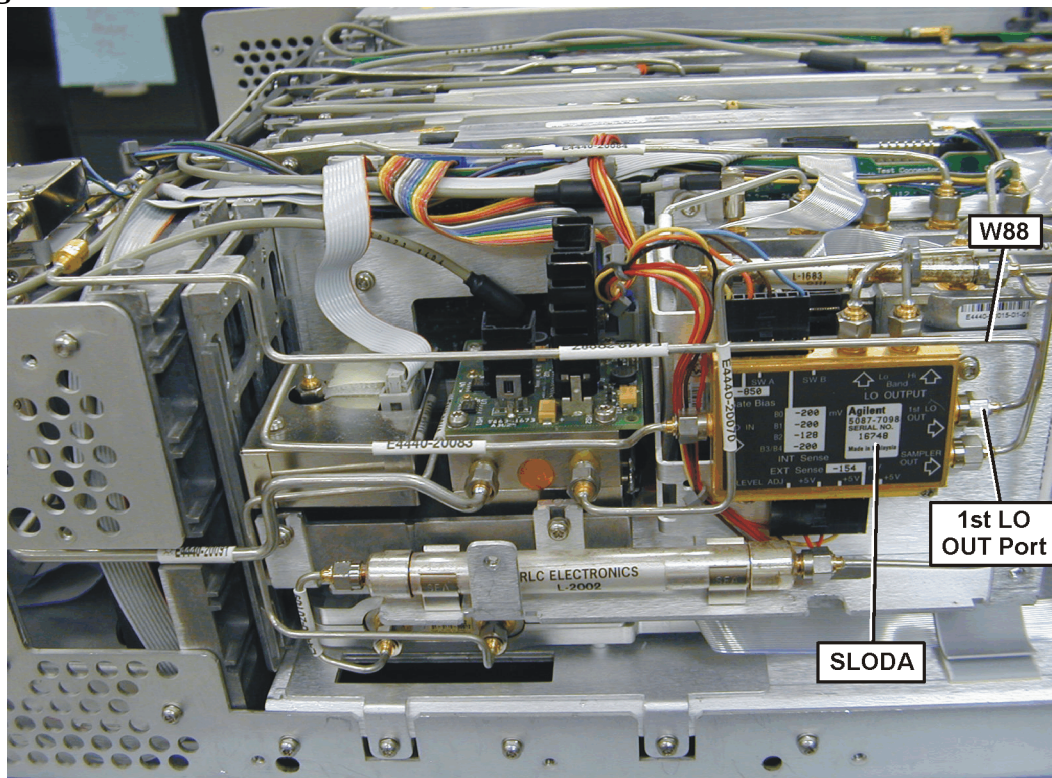

Installation Procedure

31. Locate the W83 rigid cable in the kit. Refer to [Figure 16](#). Attach one end to the Dual Mixer at the “LO IN MIXER BIAS” port. The other end attaches to the W88 cable installed in the previous step. Refer to [Figure 17](#). Assure that when the two cables are joined that the connection lays against the fan near the upper fan mounting hole. You may need to loosen the other end of W88 or W83 to achieve the proper fit. Use both the ¼-inch and 5/16-inch open-end wrenches to connect the two cables. Torque to 10 in-lbs.

Figure 16 **W83 Cable**

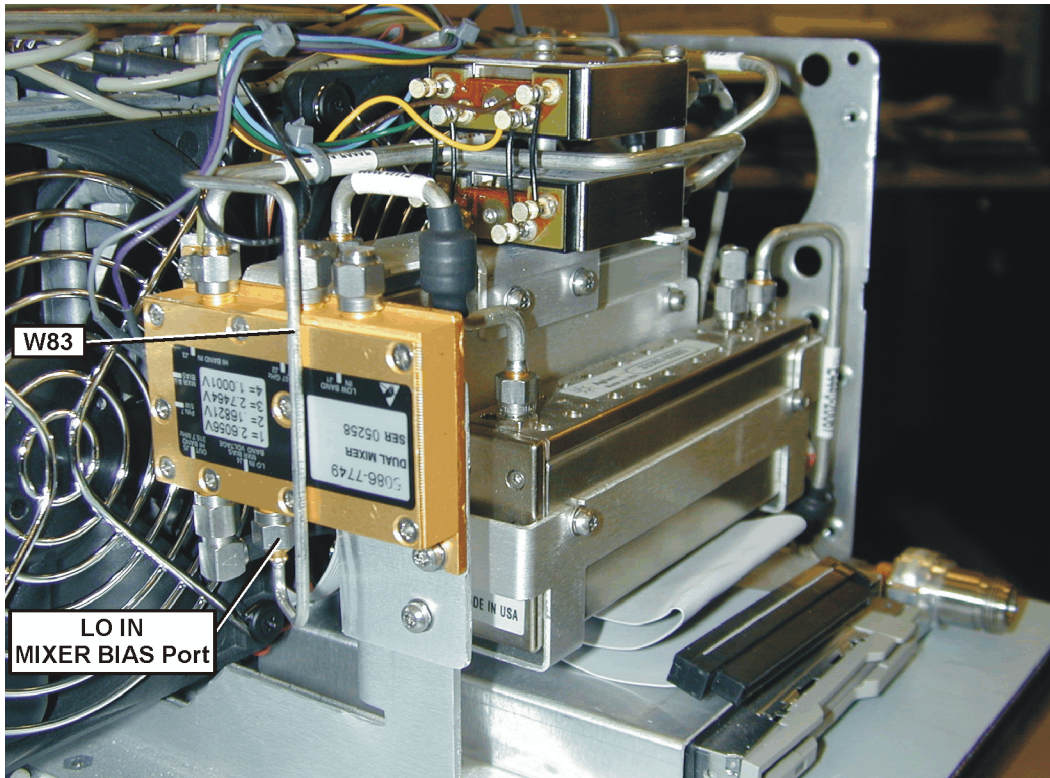
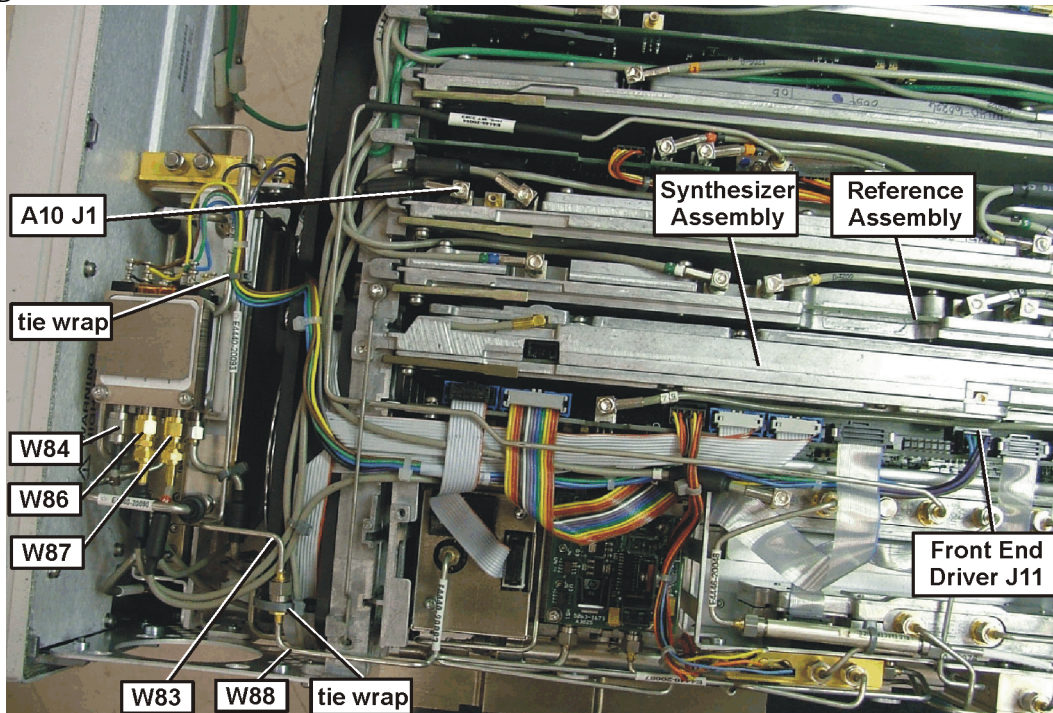
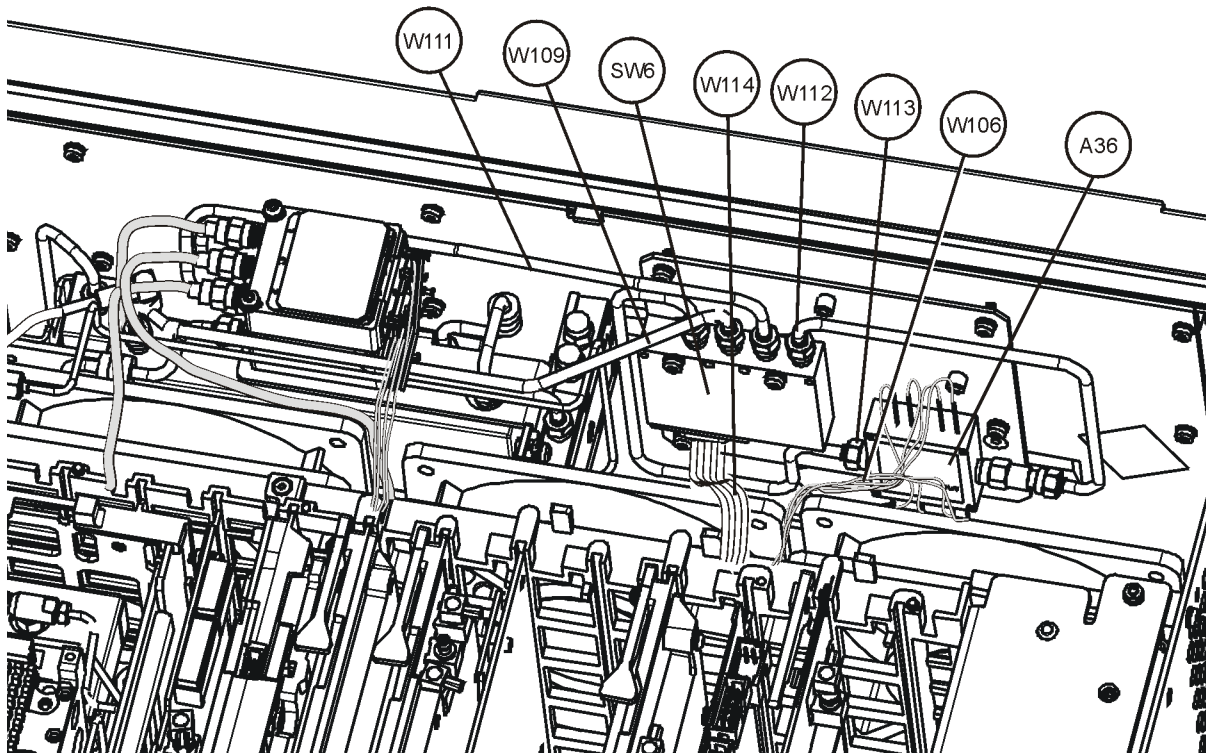

Figure 17 W83/W88 Connection and Wire Harness

32. Attach a tie wrap, included in the kit, around the W83/W88 cable connection at the fan mounting hole.
33. Attach a tie wrap, included in the kit, around the wiring harness and the rigid cable as shown in [Figure 17](#).
34. Connect the wire harness from the switch assembly to the Front End Driver assembly connector J11. Route the harness and cables as shown in [Figure 17](#).
35. Reinstall the cable hold down on the mid web after assuring the cables are routed correctly.
36. Reconnect cable W109 (A15 Attenuator to SW 6 port 2) to the attenuator. Leave loose.

Figure 18 **Option 110 (with Option 123)**



37. Locate E4440-20317 from the kit. This cable is reference designator W111. (SW 6 port 2 to SW1 port C) Connect cable to SW1 port C and leave loose.
38. Replace the front panel as described in the instructions in this installation note under the section called **“Replace the Front Frame”**.
39. Refer to **Figure 18**. Connect Cable W109 to Switch SW6 port 2. Torque both ends of this cable to 10 in-lbs.
40. Connect Cable W111 to Switch SW6 port 3. Torque both ends of this cable to 10 in-lbs.
41. The top brace and instrument enclosure must be left off because the instrument requires adjustment later in the retrofit process.
42. Skip to the section named **“Installing the Option Designator and License Keyword”**.

Remove the Front Frame

1. Refer to [Figure 19](#). Using the T-10 driver, remove the 7 screws (1) that attach the front frame assembly (2) to the deck.
2. Pull the front frame off of the deck until it is disengaged from the disc drive.
3. Using a 9/16" socket drive, remove the nut securing the **Ext Trigger Input BNC** connector. Take care to not scratch the front dress panel.
4. Disconnect the ribbon cable (3) from the A2 front panel interface board. Pull the coaxial cable (4) from the front frame and unclip from the two cable clamps.
5. Lift the front frame assembly away from the deck.

Figure 19 **Front Frame Assembly Removal**

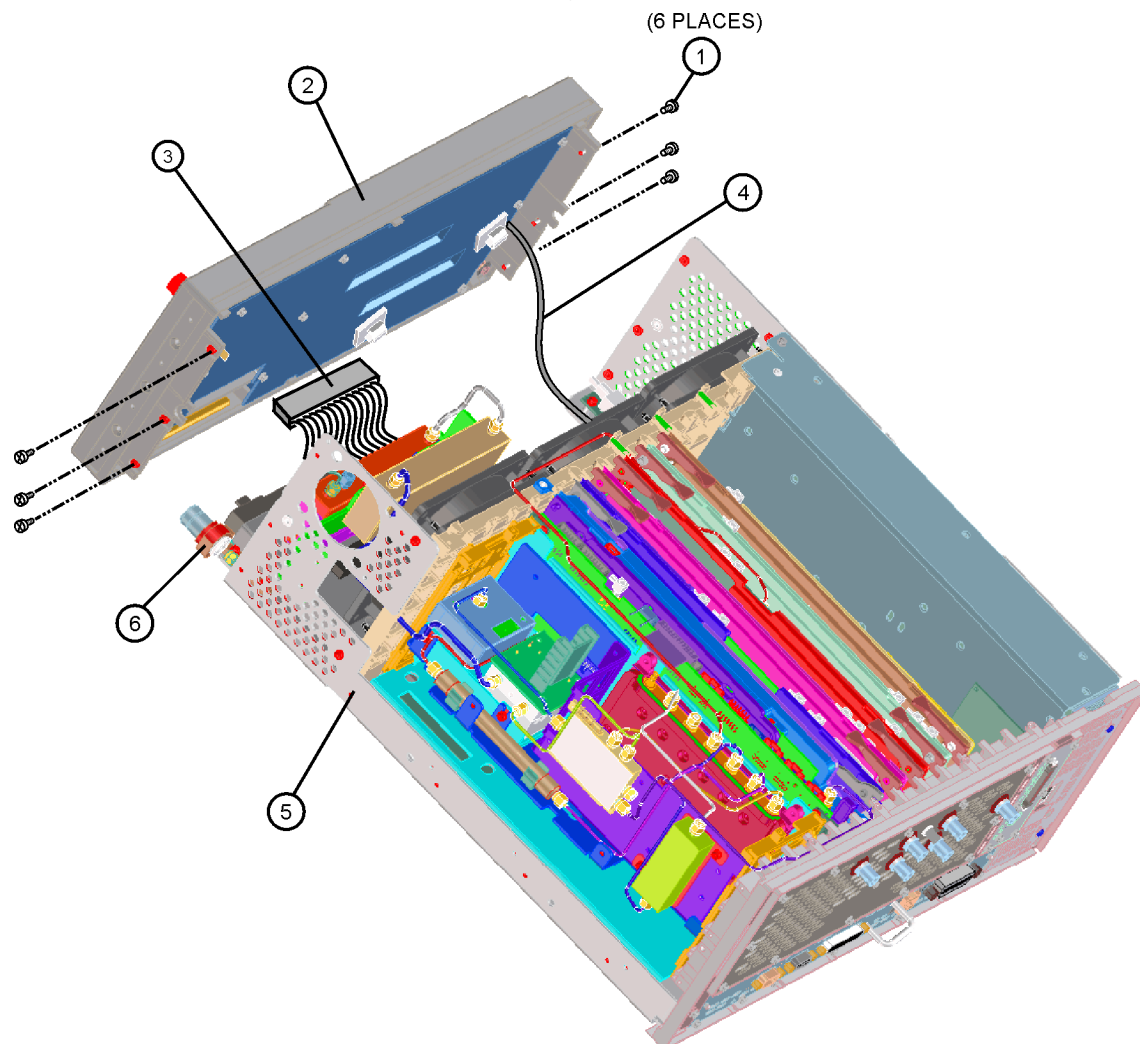

se86a

Installing Option 123 without Option 110

1. Locate the input attenuators near the RF input and remove the W8, E4440-20068 rigid cable that connects the two attenuators. Refer to [Figure 6](#). This cable will be reused later.

Figure 20 Cable Locations

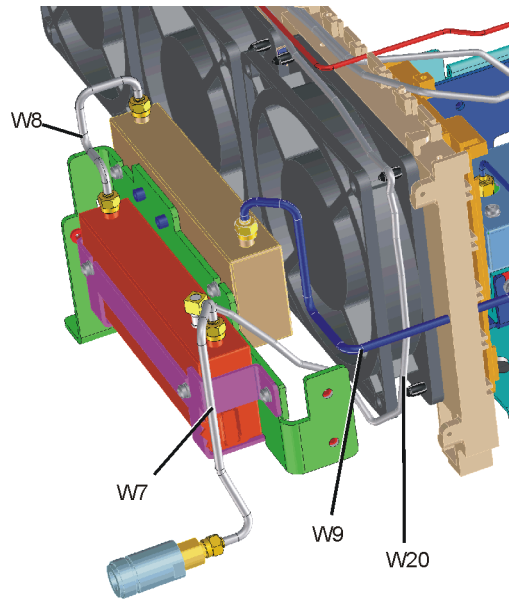

attencables

2. Locate the switch/bracket assembly in the retrofit kit ([Figure 7](#)) and place it over the attenuators as shown in [Figure 8](#). Secure the switch/bracket assembly to the attenuator bracket with the 0515-0372 screws provided in the kit.

Figure 21 Switch/Bracket Assembly

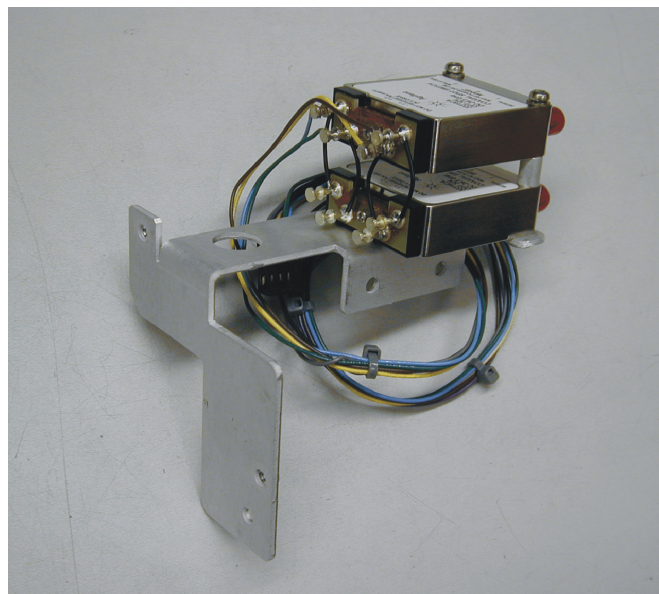

3. Locate the Dual Mixer in the kit. Look at the wire harness attached to the switch/bracket assembly and locate the grey and violet wires.
4. Refer to [Figure 9](#) to determine how the Dual Mixer will attach, but do not attach the mixer yet. Connect the grey wire with the push on connector to the Dual Mixer bias pin. Connect the violet wire with the push on connector to the Pin 7 SW on the Dual Mixer.

Figure 22 Mixer and Cable Locations

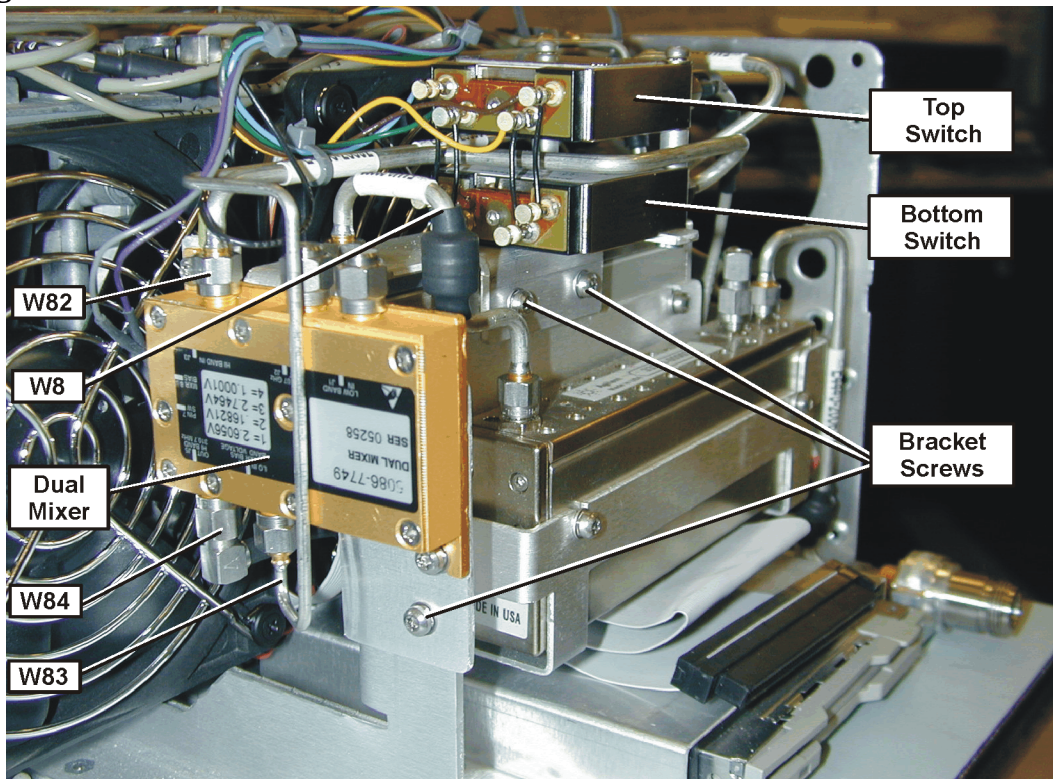

Installation Procedure

5. Refer to [Figure 9](#). Attach the Dual Mixer to the end of the switch bracket using two of the screws in the kit. Before inserting the top screw, locate the black wire with the ground lug that is part of the switch harness. Place the ground lug between the screw head and the mixer body. Torque the mounting screws to 9 in-lbs.

Figure 23 Mixer Installation

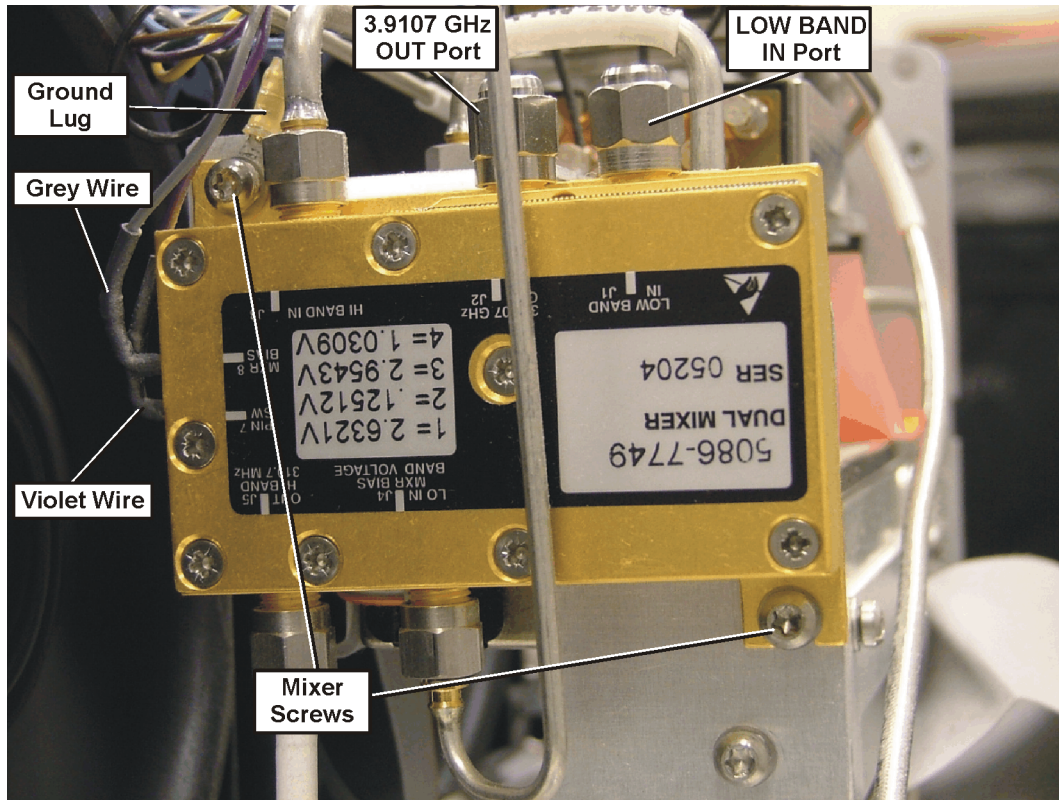

6. Refer to [Figure 6](#). Remove the W9, E4440-20069 rigid cable from the RYTHM to the attenuator. This cable can be discarded.

7. Locate the W80, E4440-20090 rigid cable in the kit. Refer to [Figure 24](#). Attach one end of the cable to the bottom switch port C, and the other end to the attenuator connector where you just removed W9. Torque to 10 in-lbs.

Figure 24 Bottom Switch Cables

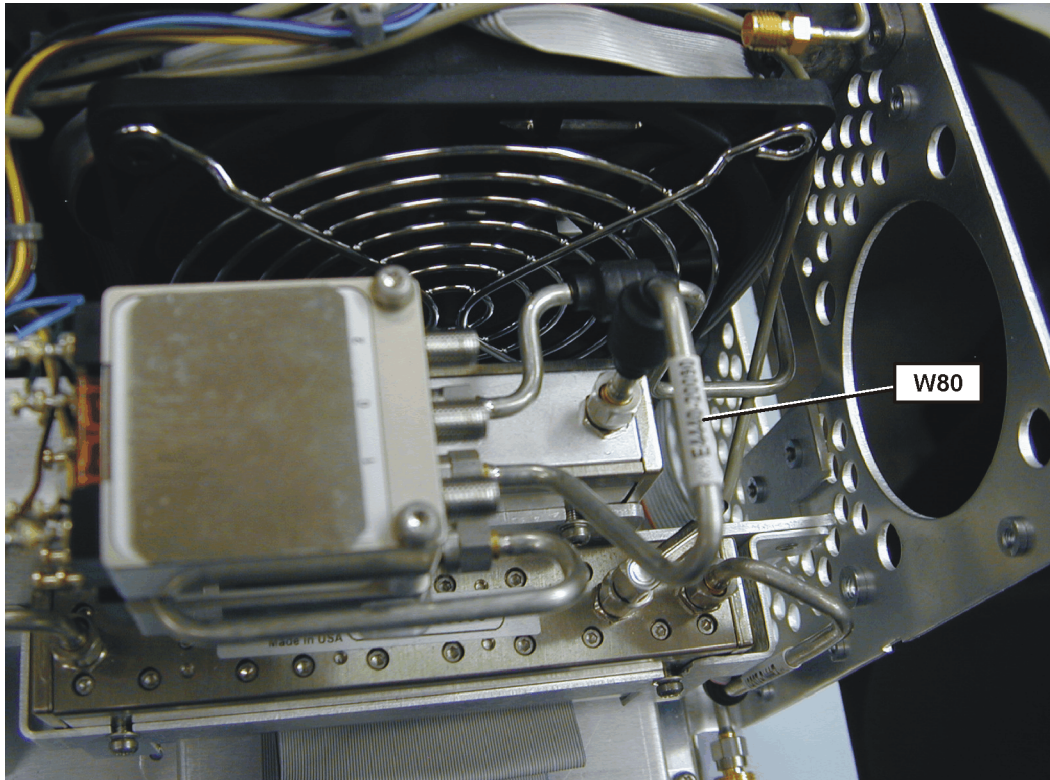

8. Refer to [Figure 10](#). Re attach the W8 rigid cable between the two attenuators. This is the cable you removed in step 1. Torque to 10 in-lbs.

Figure 25 Cable Locations

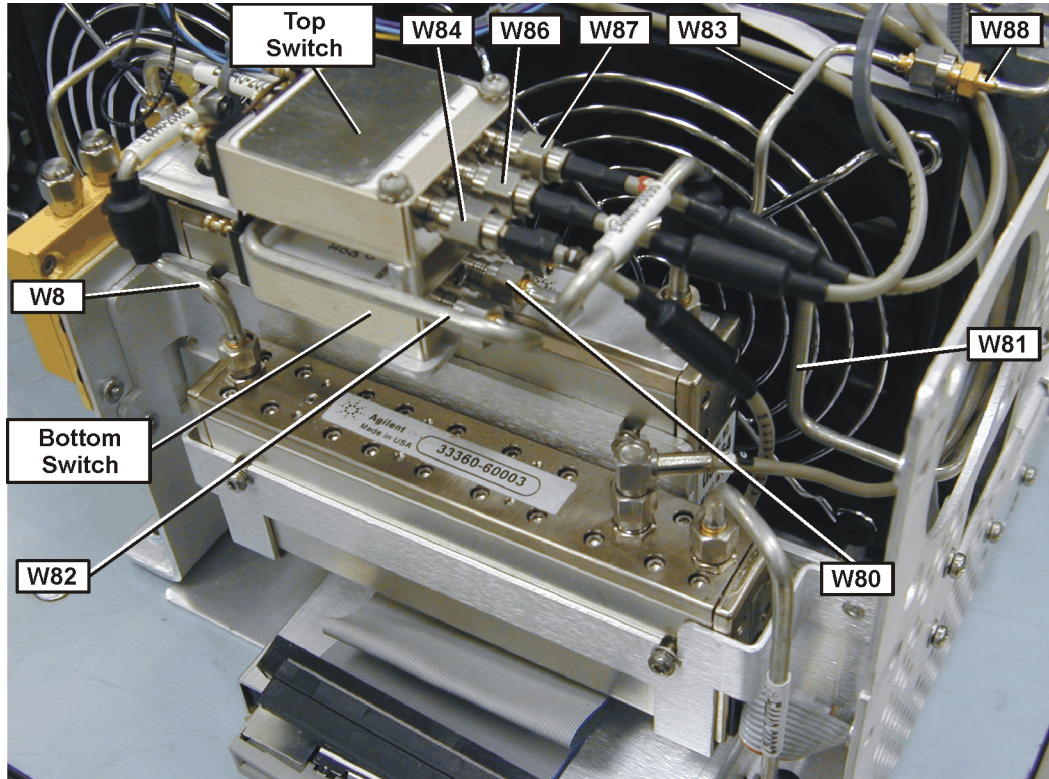
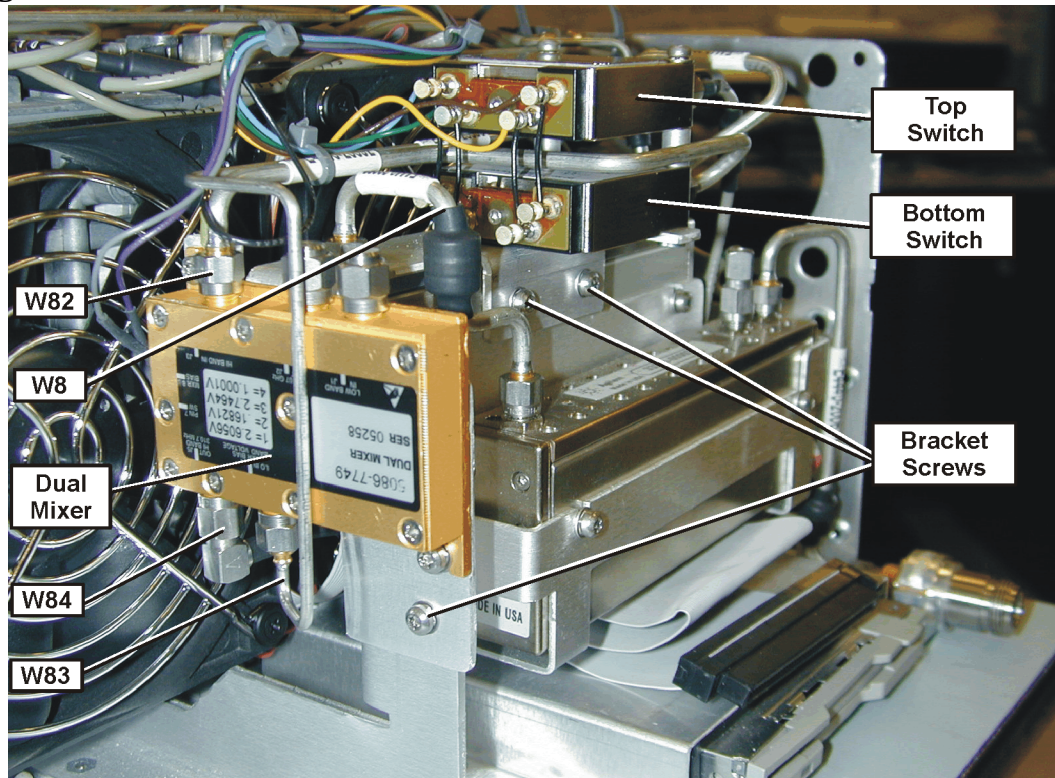

Figure 26 Mixer and Cable Locations

9. Locate the W82 rigid cable in the kit. Refer to [Figure 10](#) and [Figure 11](#). This cable will connect between the bottom switch Port 1, and Dual Mixer port “HI BAND IN J3”. The cable must be routed between the switches. To do this, make sure the flat portion of the connector nut is positioned so the end of the cable will fit between the switches. Torque the cable to 10 in-lbs.

Installation Procedure

10. Locate the W81 rigid cable in the kit. Refer to [Figure 10](#) and [Figure 12](#). This cable will connect between bottom switch Port 2, and the RYTHM port.

Figure 27 W81 Location

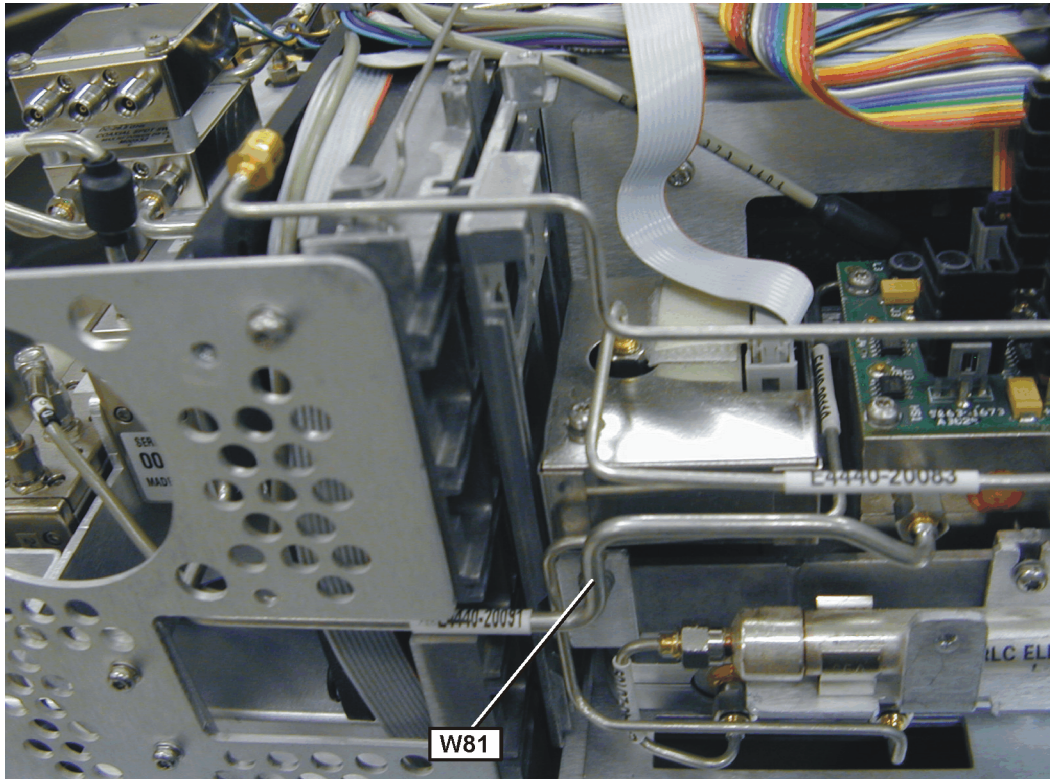

11. Refer to [Figure 13](#). On the instrument, locate the flexible coax “10” cable that connects between the A10 Third Converter J1 and RYTHM. Remove the cable from Third Converter J1.

Figure 28 Top View

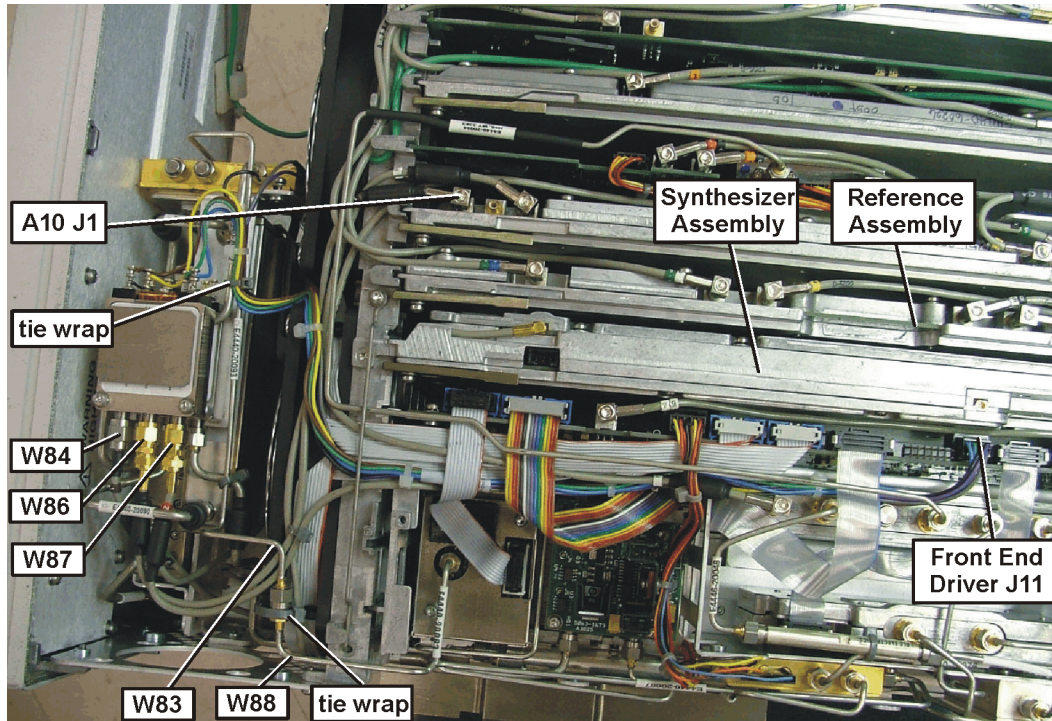

12. Remove the screw from the cable hold down rod on the mid web to allow the “10” cable and other cables to be free.
13. In order to remove the RYTHM end of the cable, and replace the cable, several board assemblies must be removed. Please note the position and routing of all cables. All of the flexible coax cables are color coded, but the ribbon cables are not.
14. Remove the Front End Driver being careful to avoid damaging the ribbon cables.
15. Remove the Synthesizer assembly after removing the rigid cable and the two retaining screws.
16. Remove the Reference assembly.

17. Locate the “10” cable again, and take note of the cable routing. Refer to [Figure 14](#). Using needle nose pliers, carefully grab the body of the “10” cable smb connector and gently rock the smb connector free of the RYTHM. Discard the cable.

Figure 29 RYTHM SMB Connector

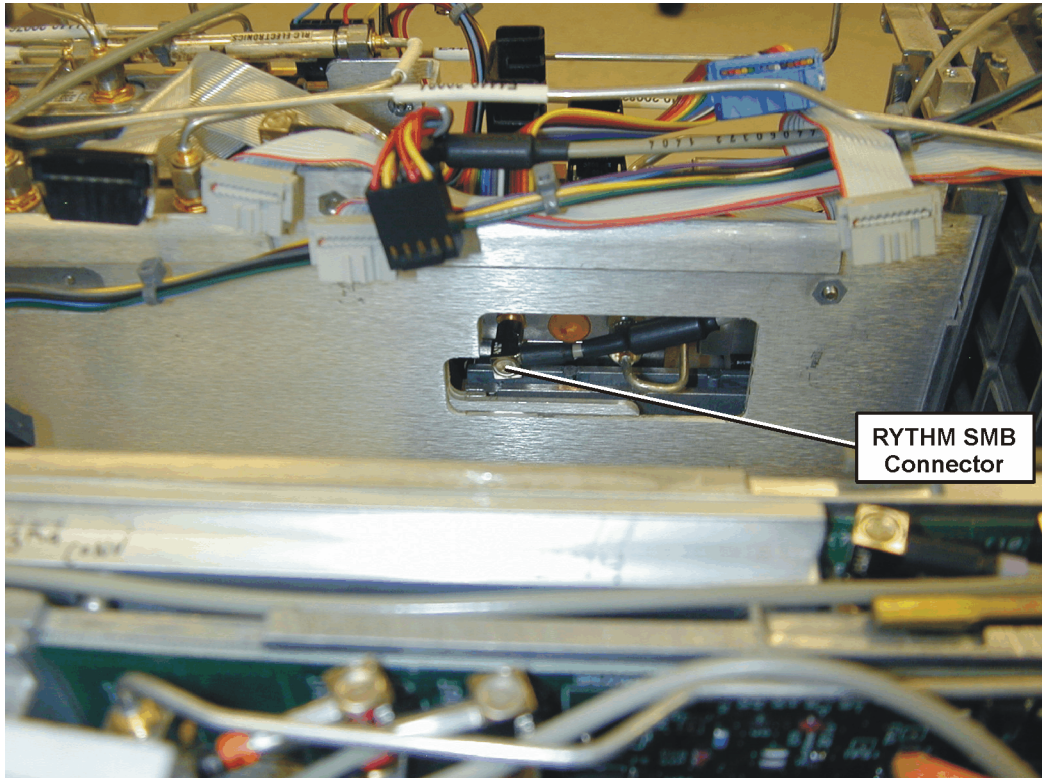

18. Locate the W87 flexible coax in the kit. This cable has a “2” color code and connects from port 2 of the top switch to the smb connector on RYTHM. Route the SMA end of the cable under the W80 semi-rigid cable, and connect it to port 2 of the top switch. Torque to 10 in lbs. Route the cable next to the RF section sheet metal and directly to the RYTHM. Carefully align the SMB end of the cable with the RYTHM connector by looking through the hole in the chassis. Press the SMB connector on.
19. Reinstall the A13 Front End Driver, Synthesizer Assembly and the Reference Assembly. Assure all cables are routed correctly.
20. Locate the W86 flexible coax cable in the kit. This cable has a 10 color code on one end and a “C” on the other end. Refer to [Figure 13](#). Route the SMA end of the cable under the W80 semi-rigid cable, and connect it to the center port of the top switch. Torque to 10 in lbs. Attach the other end of the cable to the A10 Third Converter J1 connector.

NOTE The shrink-wrapped ferrite beads on the cable can be moved slightly to aid cable routing.

21. Locate the W84 flexible cable in the kit. This cable has a right-angle SMA connector on one end. Refer to [Figure 10](#) and [Figure 11](#). Route the end of the cable with the straight SMA connector under the W80 semi-rigid cable, and connect it to port 1 of the top switch. Route the cable under the attenuator and to the Dual Mixer “OUT” J5 port. Connect the cable being careful that the right-angle connector is clear of the cooling fan. Torque the connectors to 10 in-lbs.
22. Refer to [Figure 15](#). Locate the SLODA (LO distribution amplifier) in the RF section. Remove the 50 ohm load from the 1st LO OUT port. If Option AYZ was previously uninstalled, the load will not be present.
23. Refer to [Figure 9](#). Place the 50 ohm load on the Dual Mixer 3.9107GHz OUT port. If Option AYZ was previously uninstalled, use the 50 ohm load that was saved from [step 5](#) in the section “[Uninstalling Option AYZ](#)”.
24. Locate the 50 ohm load in the kit and install it on the Dual Mixer, LOW BAND IN port.
25. Locate the W88 rigid cable in the kit. Refer to [Figure 15](#). Attach one end to the LO OUT port of the SLODA. The other must lay against the fan near the upper fan mounting hole.

Figure 30 RF Section

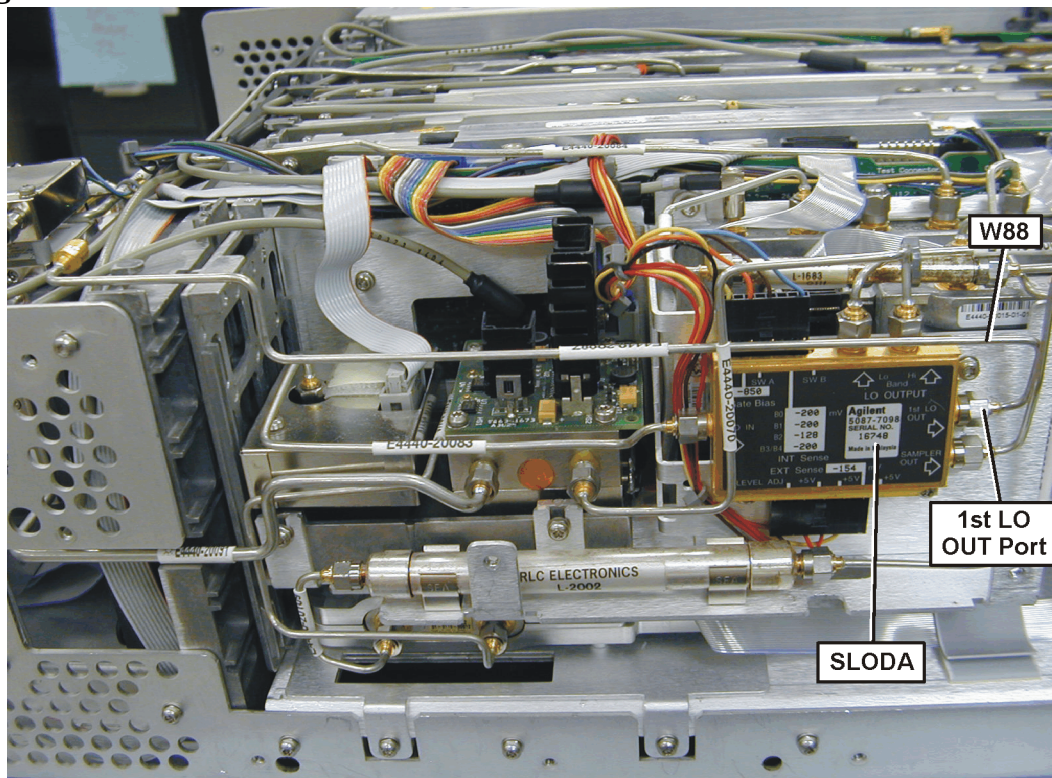

Installation Procedure

26. Locate the W83 rigid cable in the kit. Refer to [Figure 16](#). Attach one end to the Dual Mixer at the “LO IN MIXER BIAS” port. The other end attaches to the W88 cable installed in the previous step. Refer to [Figure 17](#). Assure that when the two cables are joined that the connection lays against the fan near the upper fan mounting hole. You may need to loosen the other end of W88 or W83 to achieve the proper fit. Use both the ¼-inch and 5/16-inch open-end wrenches to connect the two cables.

Figure 31 W83 Cable

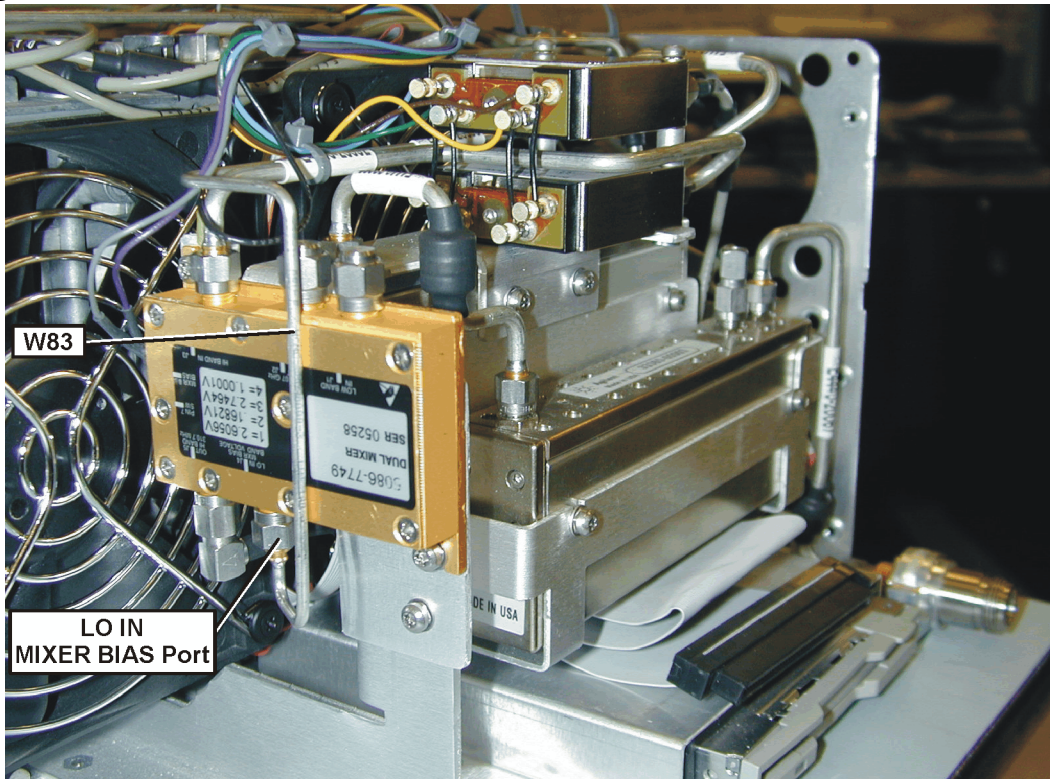
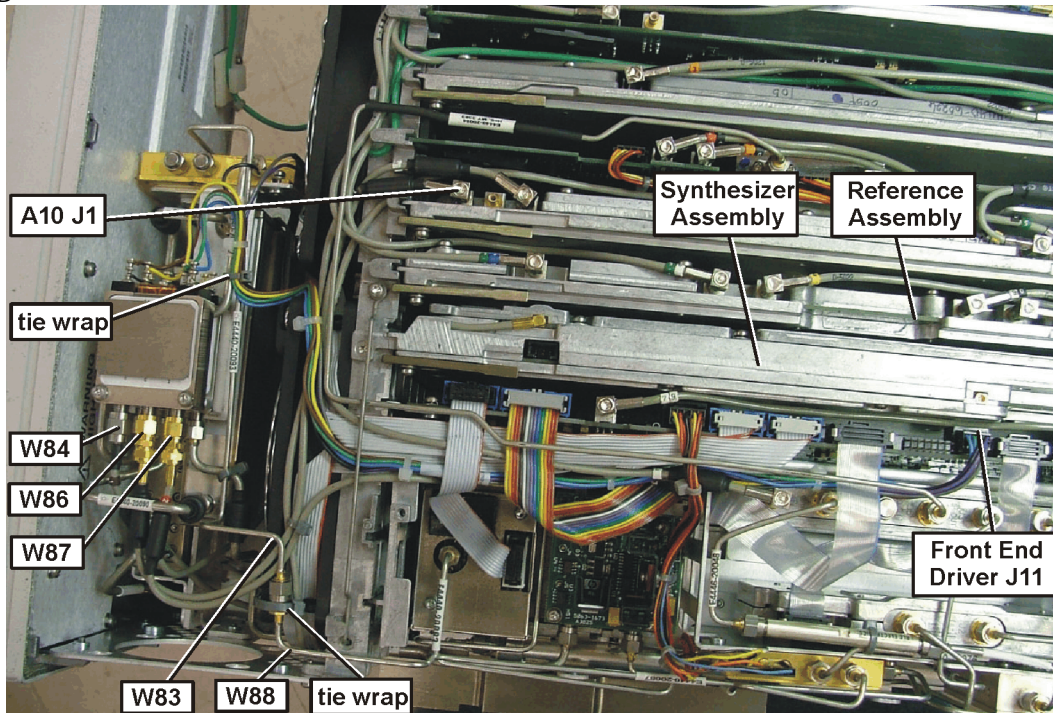

Figure 32 W83/W88 Connection and Wire Harness

27. Attach a tie wrap, included in the kit, around the W83/W88 cable connection at the fan mounting hole.
28. Attach a tie wrap, included in the kit, around the wiring harness and the rigid cable as shown in [Figure 17](#).
29. Connect the wire harness from the switch assembly to the Front End Driver assembly connector J11. Route the harness and cables as shown in [Figure 17](#).
30. Reinstall the cable hold down on the mid web after assuring the cables are routed correctly.
31. The top brace and instrument enclosure must be left off because the instrument requires adjustment later in the retrofit process.

Replace the Front Frame

1. Place the front frame assembly in front of the deck.
2. Connect the ribbon cable (3) to the A2 front panel interface board.
3. Feed the coaxial cable BNC connector through the **External Trigger Input** hole in the front frame, matching the “D” slot. Secure with the nut removed earlier, using a 9/16” socket. Torque to 21 inch pounds.
4. Clip the coaxial cable into the two cable clamps positioned on the front frame shield.
5. Position the front frame on the deck using the alignment bosses on the deck (5). Remember to tuck the ribbon cable under the fans when pushing the frame onto the deck. This will insure proper airflow to cool the instrument. Using the T-10 driver, replace the 7 screws (1) that secure the front frame to the deck. Torque to 9 inch pounds.

Installing the Option Designator and License Keyword

NOTE The option designator 123 and the license keyword must be entered into instrument memory in addition to the correct firmware before the hardware will function.

1. Locate the License Key Entitlement Certificate in the kit and follow the directions to redeem it. You will receive a License keyword Certificate that has the license keyword required for [step 4](#).
2. Plug in instrument and power up.
3. On the instrument front panel press: **System, More**, until the **Licensing** softkey is visible. Press **Licensing** and **Option**. This will activate the alpha editor menu. Use the alpha editor and the front panel numerical keypad to enter the upper-case option designator 123. Enter the letters using the alpha editor and the numeric keypad to enter the numbers. Press the **Enter** key. Note that 123 now appears on the **Option** key.
4. Press **License Key**. The license keyword is a hexadecimal number that will require the entry of both letters and numbers. Use the alpha editor and the front panel numerical keypad to enter the license key number. Your entry will appear in the active function area of the display. If you make a typing error, use the backspace key to correct the error. Check the license key number you entered. Press **Enter, Activate License**.
5. Cycle instrument power and allow instrument to perform the auto align routine.

Perform Adjustments and Performance Tests

Adjustments Required

The adjustments listed below are required following the kit installation.

Perform the adjustments in the order listed.

Performance Testing Required

The performance tests listed below are the minimum set that will verify the hardware retrofit just installed is functioning correctly. Performing only these tests does not guarantee the instrument meets all specifications.

A full calibration is required to assure the instrument meets all specifications.

Adjustments and performance testing requires the use of the calibration software. The latest software information and downloads are available at <http://www.agilent.com/find/calibrationsoftware>

NOTE	The SLODA and Mixer Bias Adjustments require access to the inside of the instrument. After this adjustment, replace the top brace before continuing with the other adjustment and performance tests. The top brace allows correct air flow.
-------------	--

Load the calibration software on your PC

Perform the following adjustments and performance tests:

Adjustments	Performance Tests
SLODA Adjust	Residuals
Dual Mixer Bias Adjustment	Displayed Average Noise Level
Frequency Response Adjustment (Option 123)	Spurious Responses
Frequency Response Adjustment (Option 110) if Option 110 is present	Frequency Response >3 GHz standard test
	Frequency Response (Option 123)
	Frequency Response (Option 110) if Option 110 is present

For assistance, contact the nearest Agilent Technologies Sales and Service Office. To find your local Agilent office access the following URL:

<http://www.agilent.com/find/assist>

Replace the Outer Case

1. Refer to [Figure 1](#).
2. Slide the instrument cover back onto the deck from the rear. The seam on the cover should be on the bottom. Be sure the cover seats into the gasket groove in the front frame.
3. Replace the four rear feet onto the rear of the instrument. Torque to 236 Ncm (21 in-lb).
4. Use the T-20 driver to replace the handles. Torque to 236 Ncm (21 in-lb).
5. Replace the four bottom feet by pressing them into the holes in the case and sliding them in the opposite direction of the arrows until they click into place. Note that the feet at the front have the tilt stands.

Manually Verify the Option

The following test switches in and out the preselector bypass path while viewing a signal. There may be slight amplitude differences between the two signal paths.

Description	Recommended Model
Signal Source > 4 GHz	Agilent 83630B
High quality, low-loss cable, 3.5 mm	8120-4921
Adapter, N (m) to APC 3.5 (f)	1250-1744
Adapter, APC 3.5 (f) to 3.5 mm (f)	83059B

1. Preset the PSA and signal source.
2. Connect the signal source to the PSA RF input with a high quality low-loss cable.

PSA Settings	
Mode	Spectrum Analysis
Center Frequency	4 GHz
Start Frequency	3.06 GHz
Stop Frequency	10 GHz

Signal Source Settings	
Frequency	4 GHz
Amplitude	-10 dBm

3. The 4 GHz signal should appear on screen. The analyzer is currently using the preselected path.
4. On the PSA, Press **Input / Output, Microwave Preselector OFF**. The preselector is now bypassed.
5. The 4 GHz signal will still be present, however the display may show many other responses. This occurs because the preselector filter that eliminates input frequencies that cause these images, multiples, and out-of-band responses, has been bypassed by the option 123 hardware. You may also notice a step in the noise floor at the 6.6 GHz bandcrossing. This is normal performance of the option123 Dual Mixer.

End of Installation

For assistance, contact your nearest Agilent Technologies Sales and Service Office. To find your local Agilent office access the following URL:

<http://www.agilent.com/find/assist>

